

GETTING STARTED

1

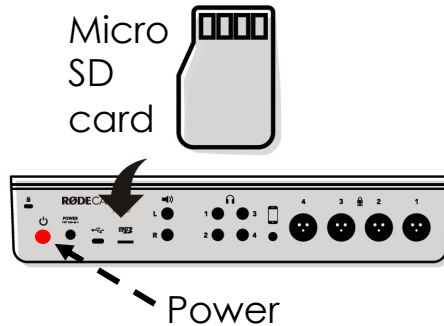

Power on and insert your Micro SD at rear. Choose 'format card' on the touch screen if prompted. **Please note formatting will erase any existing data on your card**

2

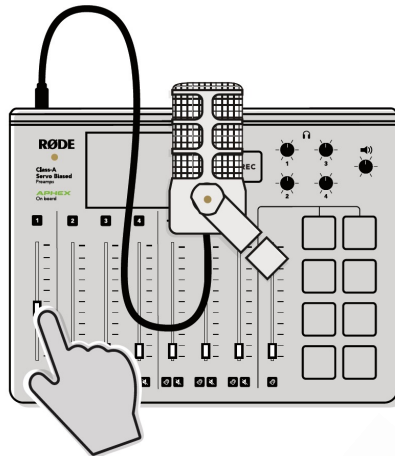

Raise the faders to set the volume for the microphones you are using. **The microphones have corresponding number labels**

3

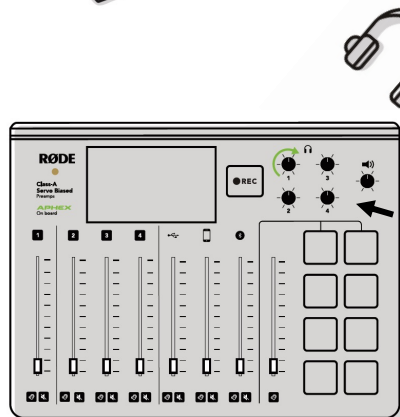

Turn up the headphone channels you wish to use. **Headphones have corresponding number labels**

4

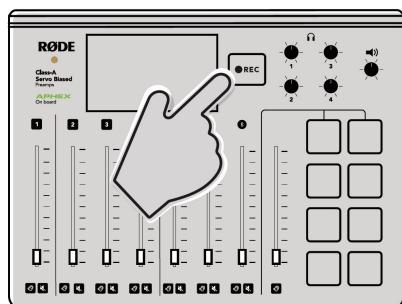

Press record to begin (hold for 2s to pause once recording)

RECORDING OVER BLUETOOTH 

1

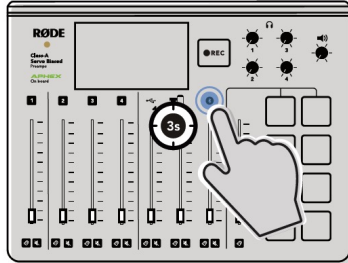

Hold the Bluetooth button for 3 seconds to enter Bluetooth pairing mode

2

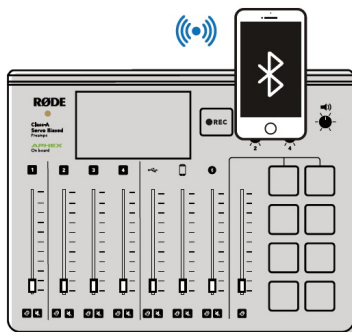

Use the Bluetooth settings on your phone to pair with **RODECASTER PRO**

3

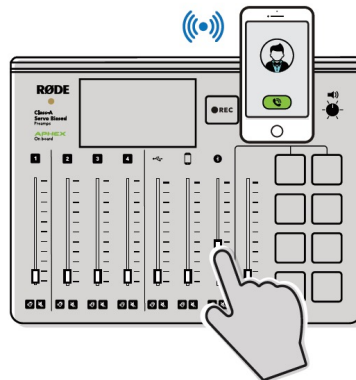

Turn up the Bluetooth fader and proceed with recording.

Mobile reception is limited so Zoom, Facetime, Whatsapp etc over Wi-Fi are recommended

If you have trouble **UNPAIR previous phones**  settings > advanced > Bluetooth

PLEASE UNPAIR your phone afterward  settings > advanced > Bluetooth



SCAN THE **QR CODE** TO LEARN MORE ABOUT THE RODECASTER